

# DURACELL®

DURALOCK  
POWER PRESERVE™



## ULTRA POWER

# MX1604

## Size: 9V (6LR61)

Alkaline-Manganese Dioxide Battery

Zn/MnO<sub>2</sub>

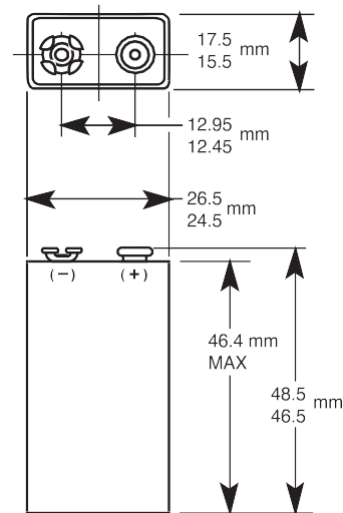

Dimensions shown are IEC standards

Nominal voltage	9 V
Impedance	1,700 m-ohm @ 1 kHz
Typical weight	45 g (1.6 oz)
Typical volume	22.8 cm <sup>3</sup> (1.4 in <sup>3</sup> )
Terminals	Miniature snap
Storage temperature range	5°C to 30°C (41°F to 86°F)
Operating temperature range	-20°C to 54°C (-4°F to 130°F)
Designation	IEC: 6LR61

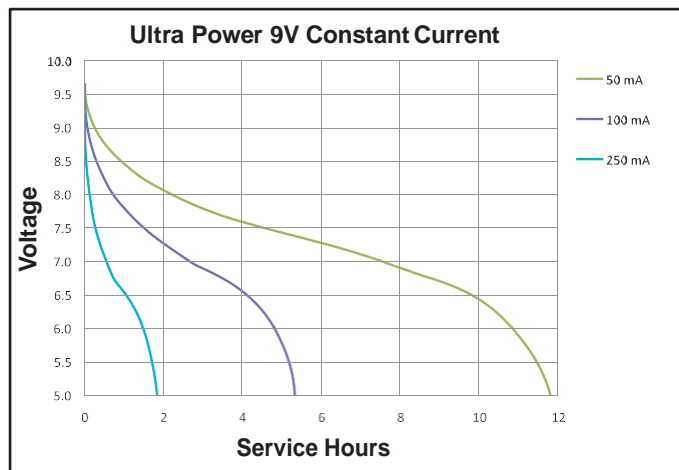
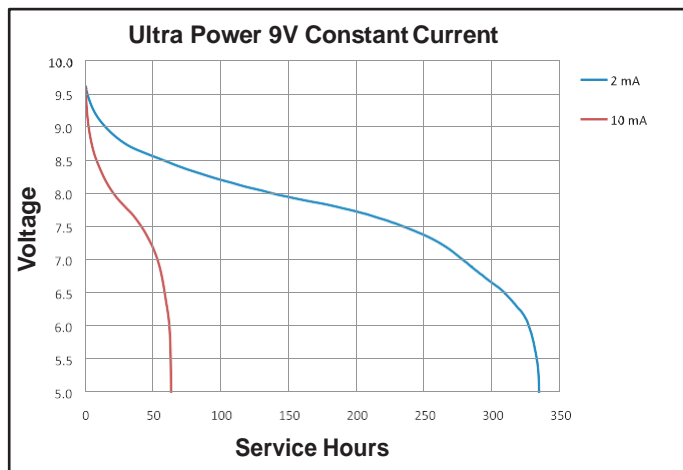

# DURACELL®

BATTERIES

Berkshire Corporate Park  
Bethel, CT. 06801 U.S.A.  
Telephone: Toll-free 1-800-544-5454  
www duracell.com

Delivered capacity is dependent on the applied load, operating temperature and cut-off voltage. Please refer to the charts and discharge data shown for examples of the energy/service life that the battery will provide for various load conditions.

# DURACELL®

DURALOCK  
POWER PRESERVE™



## ULTRA POWER

# MX1604

## Size: 9V (6LR61)

Alkaline-Manganese Dioxide Battery

Zn/MnO<sub>2</sub>

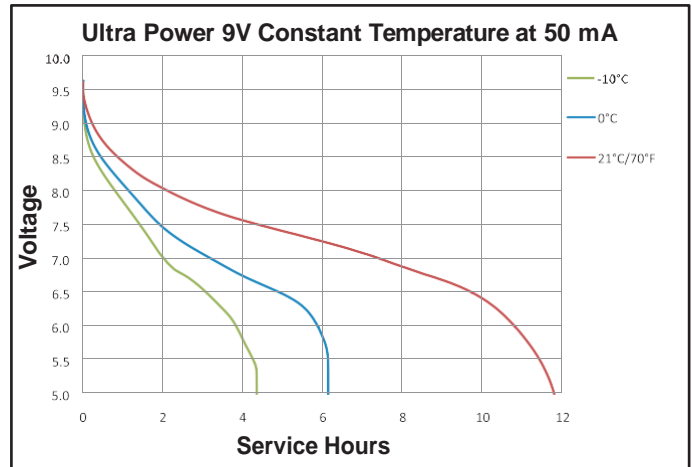
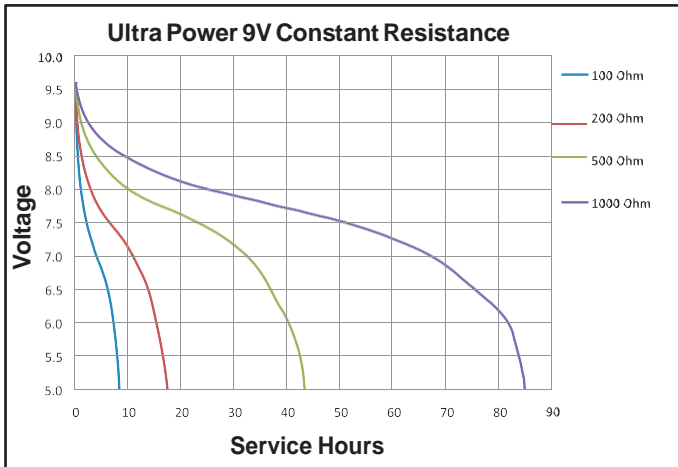
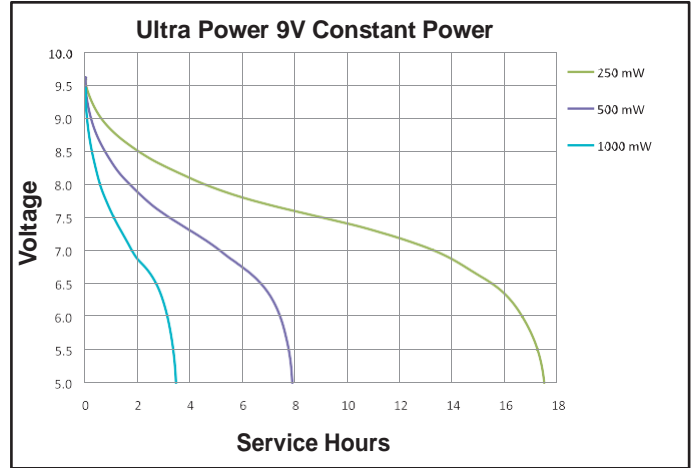
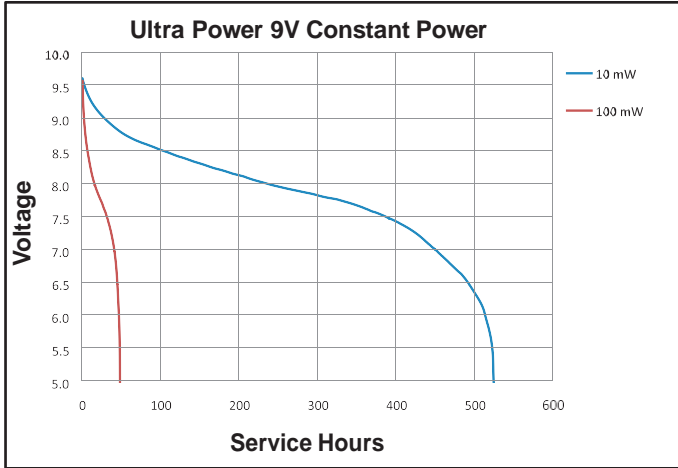

# DURACELL®

BATTERIES

Berkshire Corporate Park  
Bethel, CT. 06801 U.S.A.  
Telephone: Toll-free 1-800-544-5454  
www.duracell.com

Delivered capacity is dependent on the applied load, operating temperature and cut-off voltage. Please refer to the charts and discharge data shown for examples of the energy/service life that the battery will provide for various load conditions.