

DURACELL®

DURALOCK
POWER PRESERVE™



ULTRA POWER

MX1500

Size: AA(LR6)

Alkaline-Manganese Dioxide Battery

Zn/MnO₂



Nominal voltage	1.5 V
Impedance	81 m-ohm @ 1 kHz
Typical weight	24 g (0.8 oz)
Typical volume	8.4 cm ³ (0.5 in ³)
Terminals	Flat
Storage temperature range	5°C to 30°C (41°F to 86°F)
Operating temperature range	-20°C to 54°C (-4°F to 130°F)
Designation	IEC: LR6

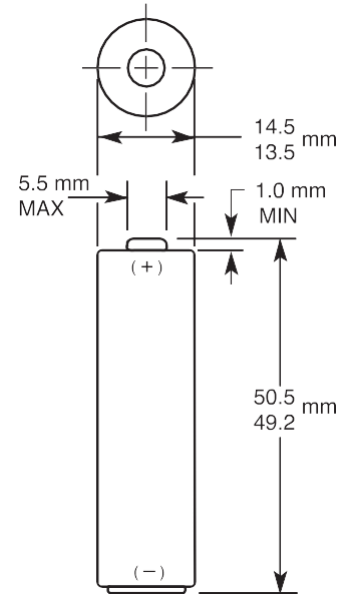

Dimensions shown are IEC standards

Ultra Power AA Constant Current

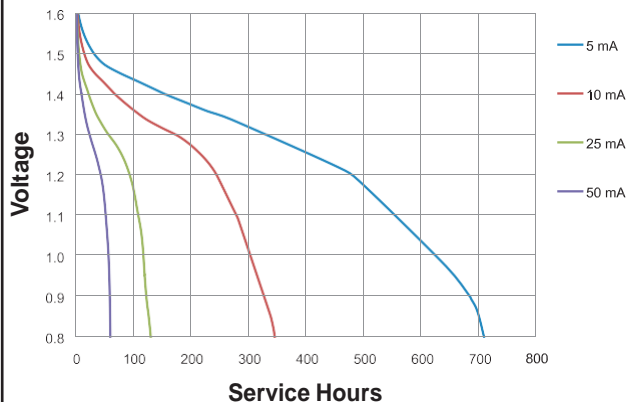

Ultra Power AA Constant Current

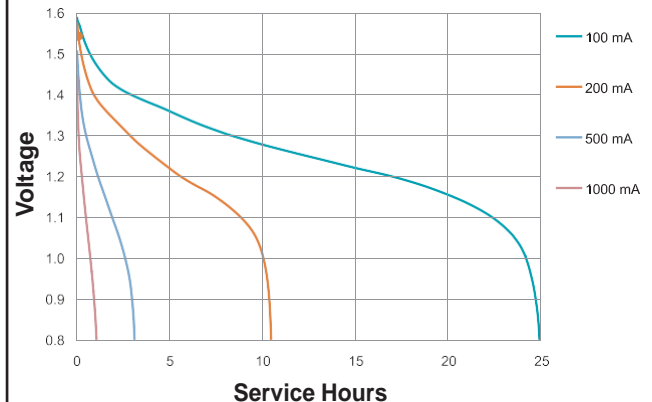

DURACELL®

BATTERIES

Berkshire Corporate Park
Bethel, CT. 06801 U.S.A.
Telephone: Toll-free 1-800-544-5454
www.duracell.com

Delivered capacity is dependent on the applied load, operating temperature and cut-off voltage. Please refer to the charts and discharge data shown for examples of the energy/service life that the battery will provide for various load conditions.

DURACELL®

DURALOCK
POWER PRESERVE™



ULTRA POWER

MX1500

Size: AA(LR6)

Alkaline-Manganese Dioxide Battery

Zn/MnO₂

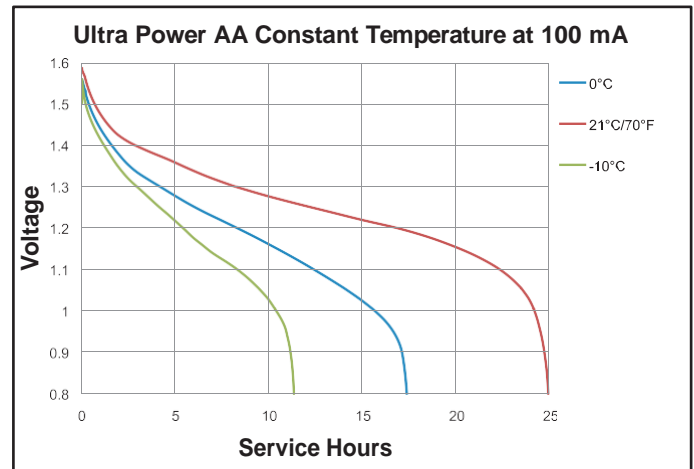
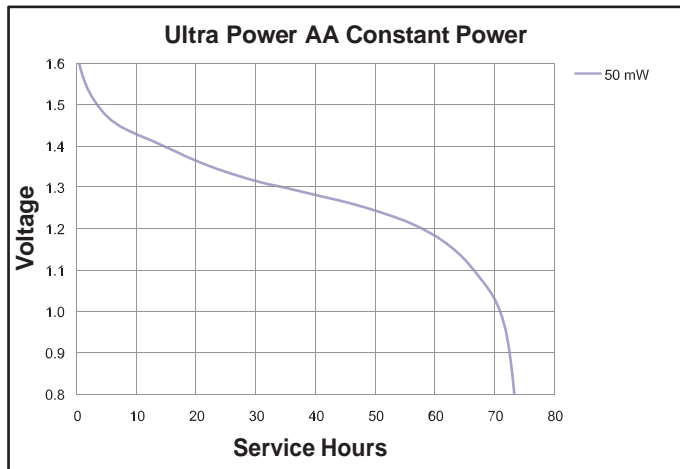
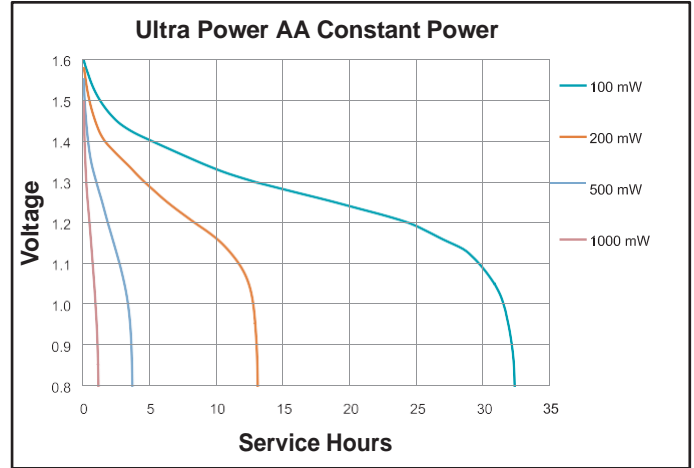
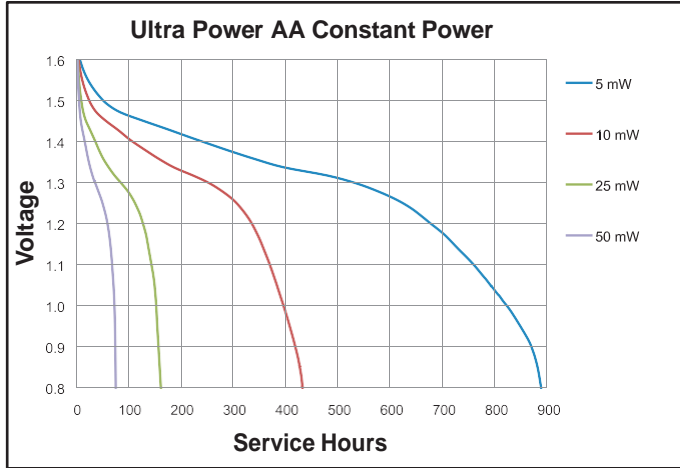

Delivered capacity is dependent on the applied load, operating temperature and cut-off voltage. Please refer to the charts and discharge data shown for examples of the energy/service life that the battery will provide for various load conditions.

DURACELL®

BATTERIES

Berkshire Corporate Park
Bethel, CT. 06801 U.S.A.
Telephone: Toll-free 1-800-544-5454
www.duracell.com

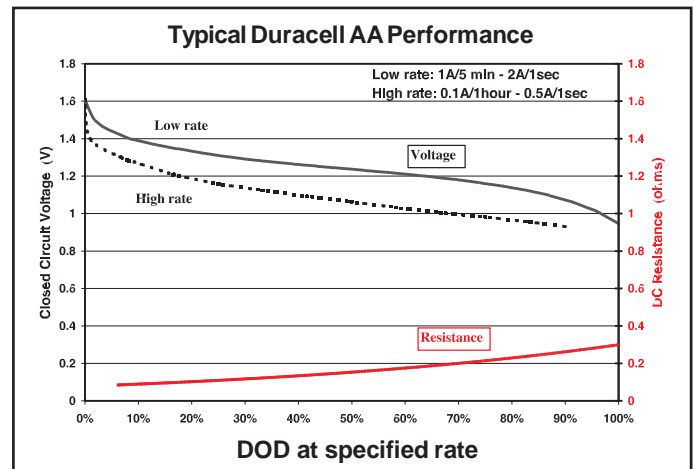

This data is subject to change. Performance information is typical. Contact Duracell for the latest information.

MX15UPWE0614